

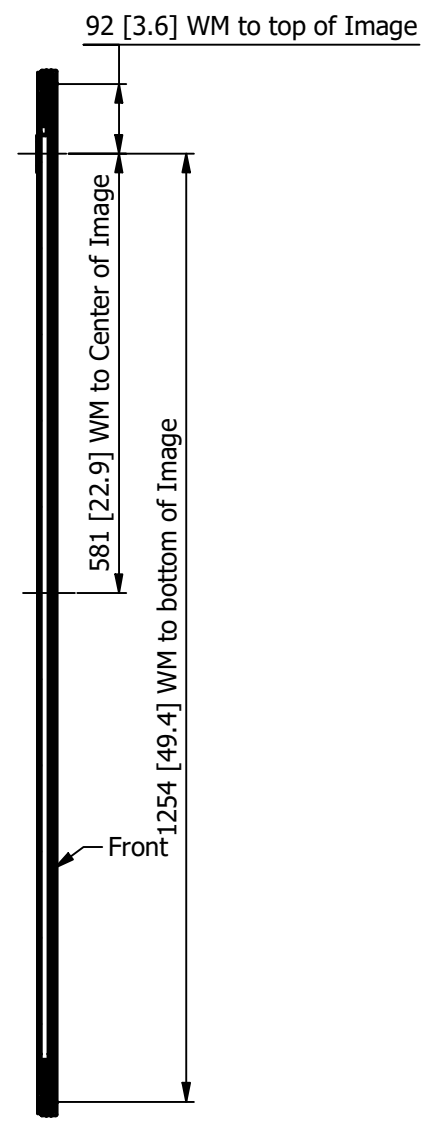

# Front View

A-A

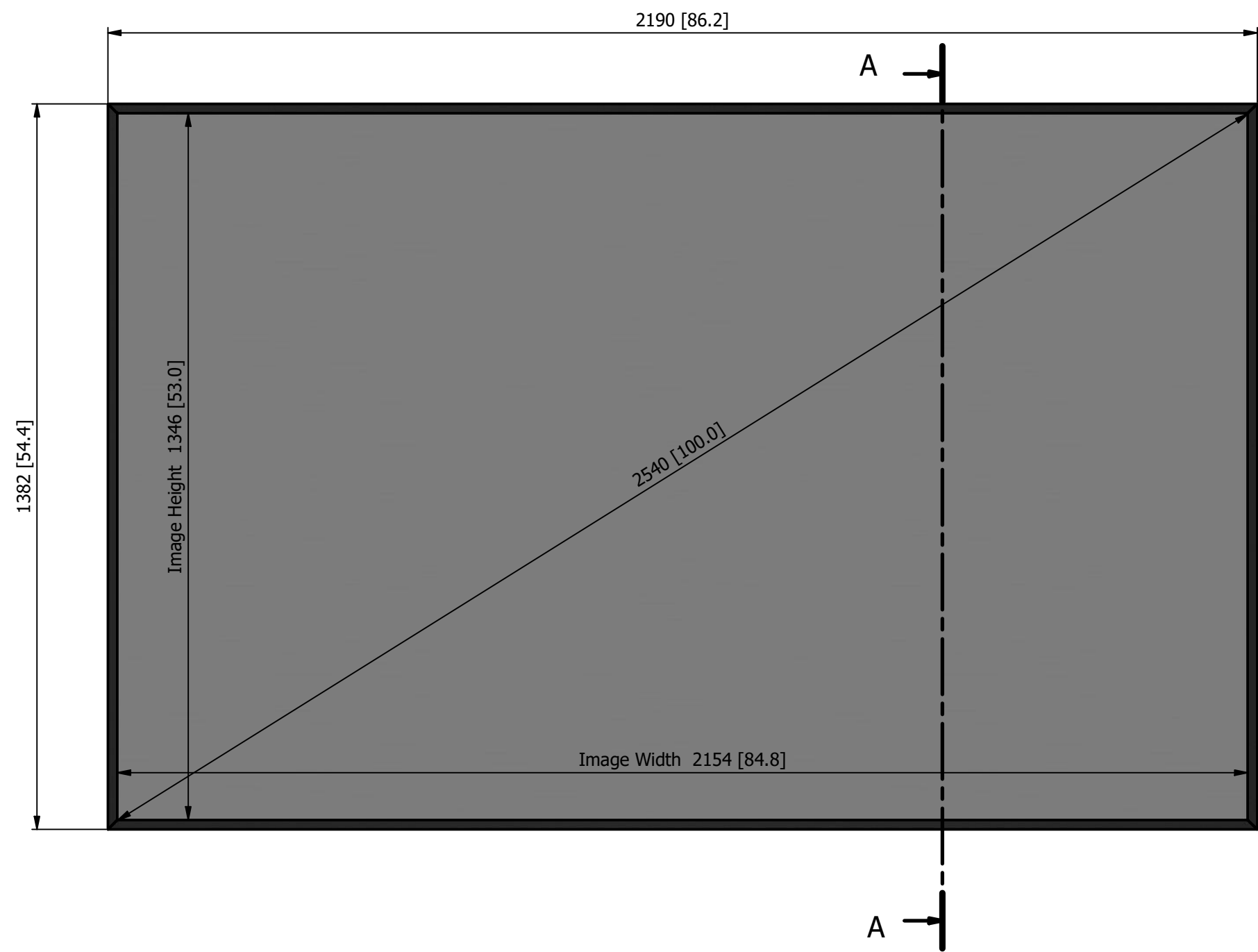

Weight 13 kg - 29 lbs

End user/project:				
Order No.:		Customer:		
dnp no.	Rev/Date/int:	Supplier:		
 dnp denmark as Skruegangen 2 DK-2690 Karlslunde Denmark Tel.: +45 46 16 51 00 Website: www.dnp-screens.com	Scale:	Date:	Sign.:	
	1:10	11/03/2019	GA	
Description: Supernova STW 100" 16:10 Layout - Main Dimensions		Sheet: 1 of 2	Format: A3	
		Drawing No: W - 538 24 100 300		

# Rear View

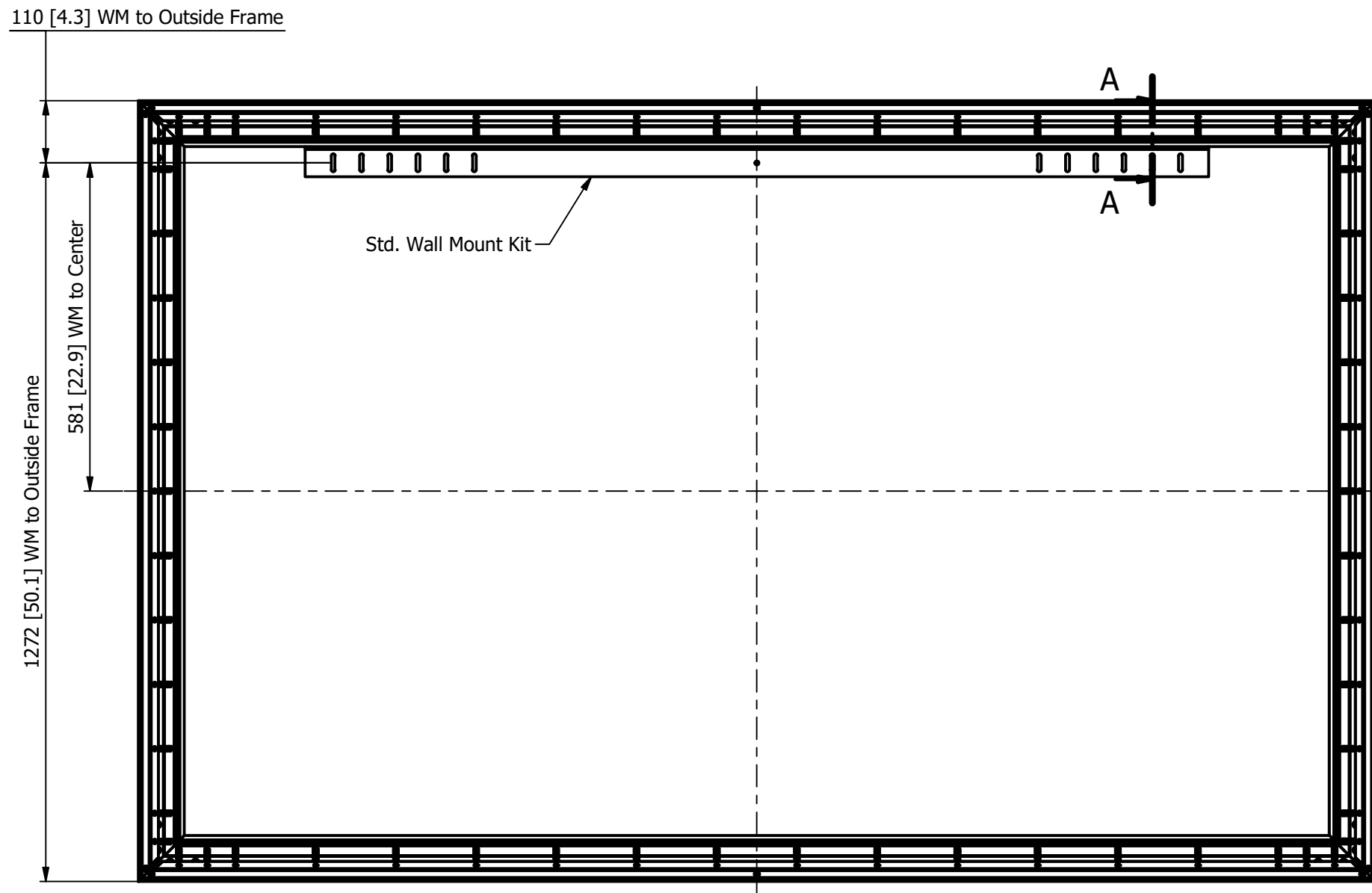

# A-A ( 1 : 1 )

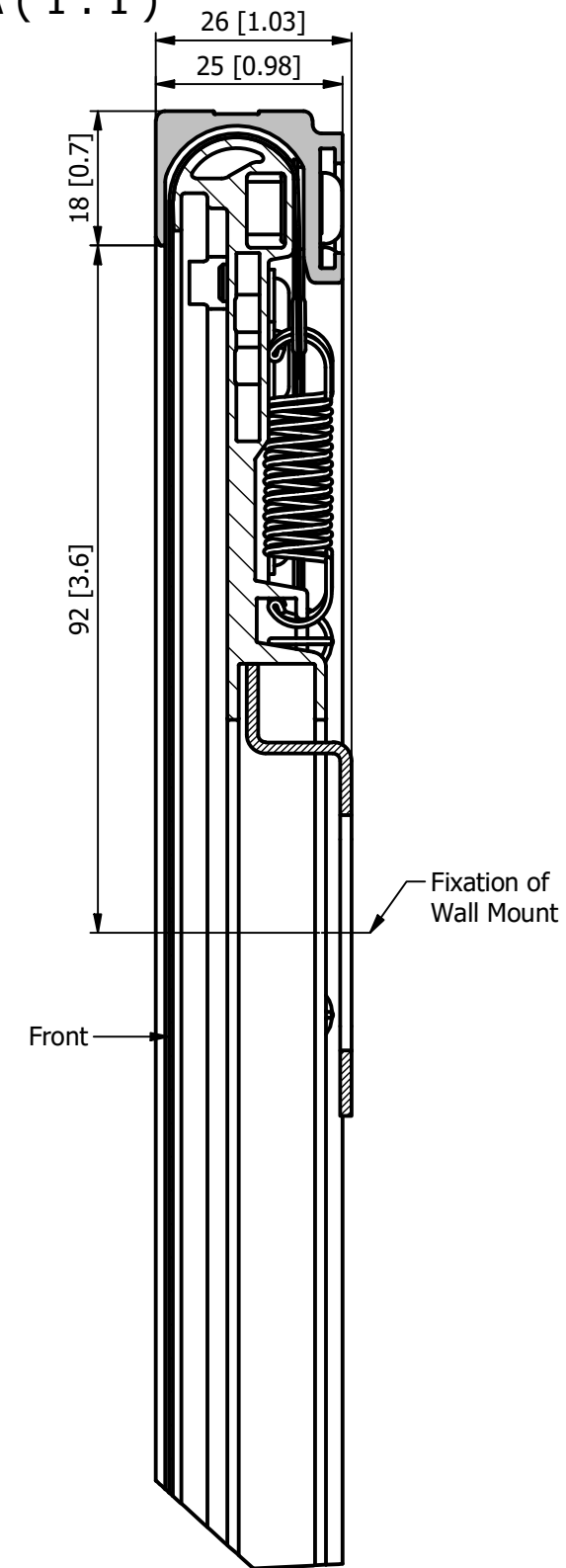

[ ] = Inch

# Standard Wall Mount (WM)

( 1 : 7,5 )

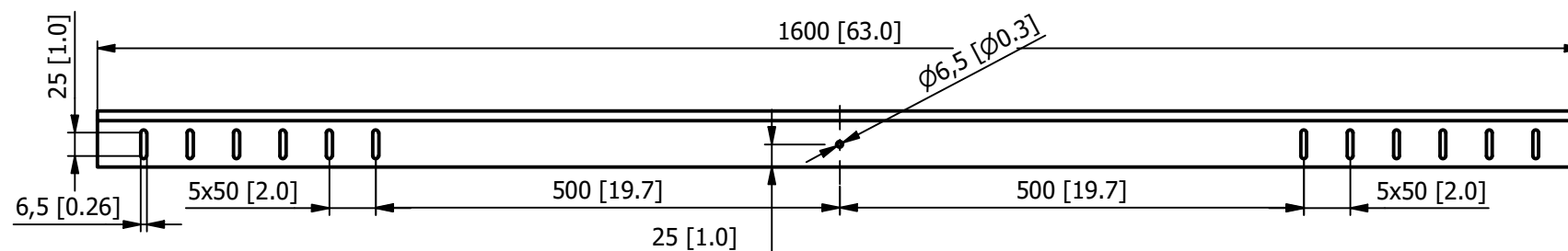

End user/project:				
Order No.:		Customer:		
dnp no.	Rev/Date/int:	Supplier:		
 dnp denmark as Skruergangen 2 DK-2690 Karlslunde Denmark Tel.: +45 46 16 51 00 Website: www.dnp-screens.com	Scale:	Date:	Sign.:	
	1:10	11/03/2019	GA	
Description: Supernova STW 100" 16:10 Rear view		Sheet: 2 of 2	Format: A3	
		Drawing No: W - 538 24 100 300		