

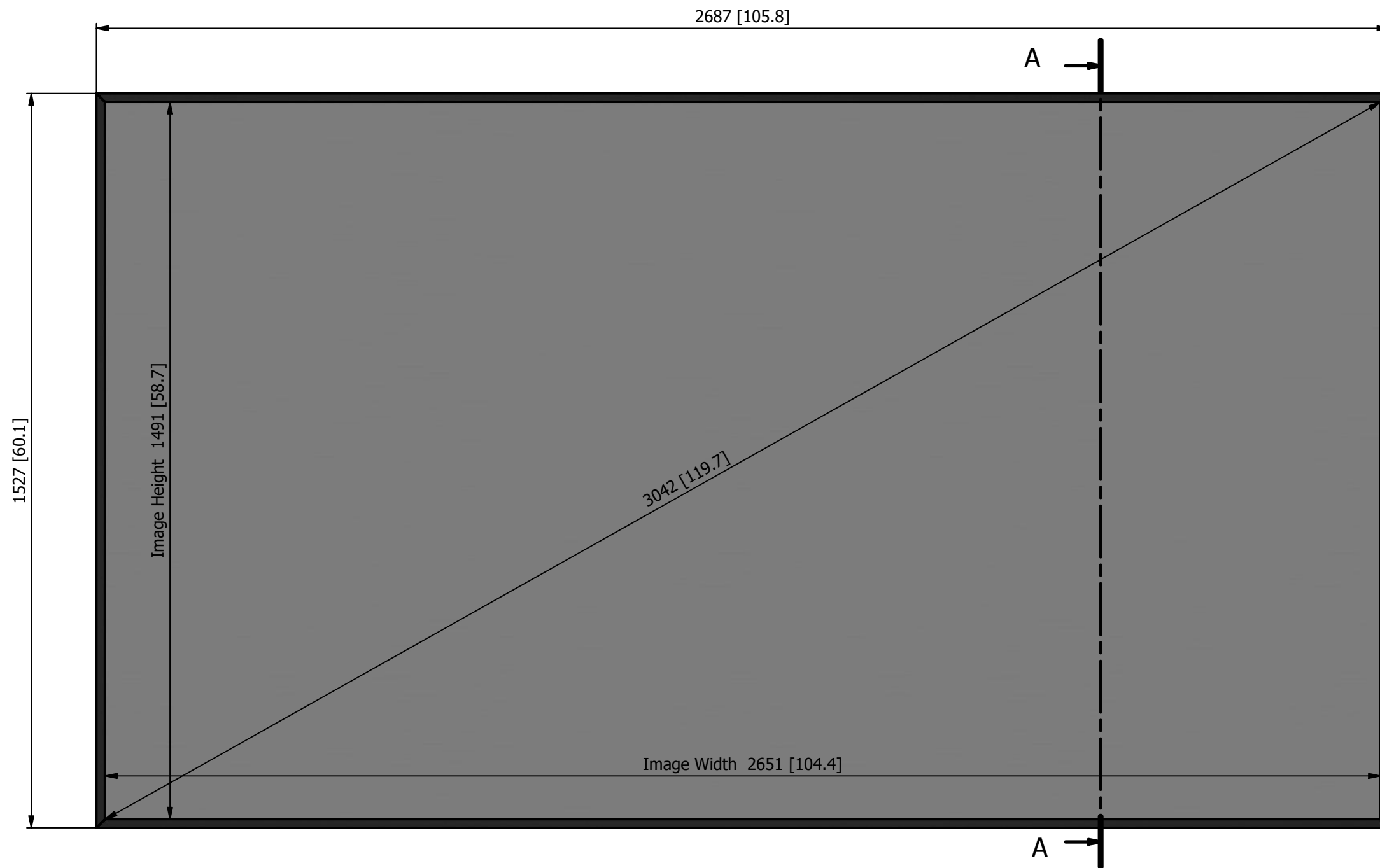

Front View

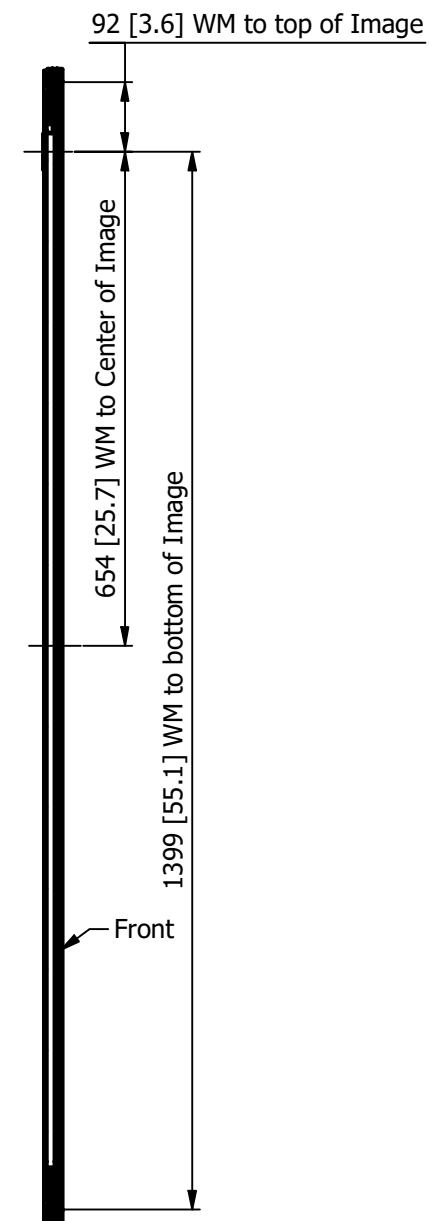

A-A



Weight 15 kg - 33 lbs

End user/project:				
Order No.:		Customer:		
dnp no.	Rev/Date/int:	Supplier:		
 dnp denmark as Skruegangen 2 DK-2690 Karlslunde Denmark Tel.: +45 46 16 51 00 Website: www.dnp-screens.com	Scale:	Date:	Sign.:	
	1:10	25/02/2019	GA	
Description:		Sheet: 1 of 2	Format: A3	
Supernova STW 120" 16:9 Layout - Main Dimensions		Drawing No: W - 538 24 120 100		

D:\P (GA) Tegninger (Sync)_221118\Div Produkter\STW NEW_Standard size\STW 120in 1.78W - 538 24 120 100.idw

Measure without tolerance according DS/ISO 2768-m

Copyright dnp denmark as

Rear View

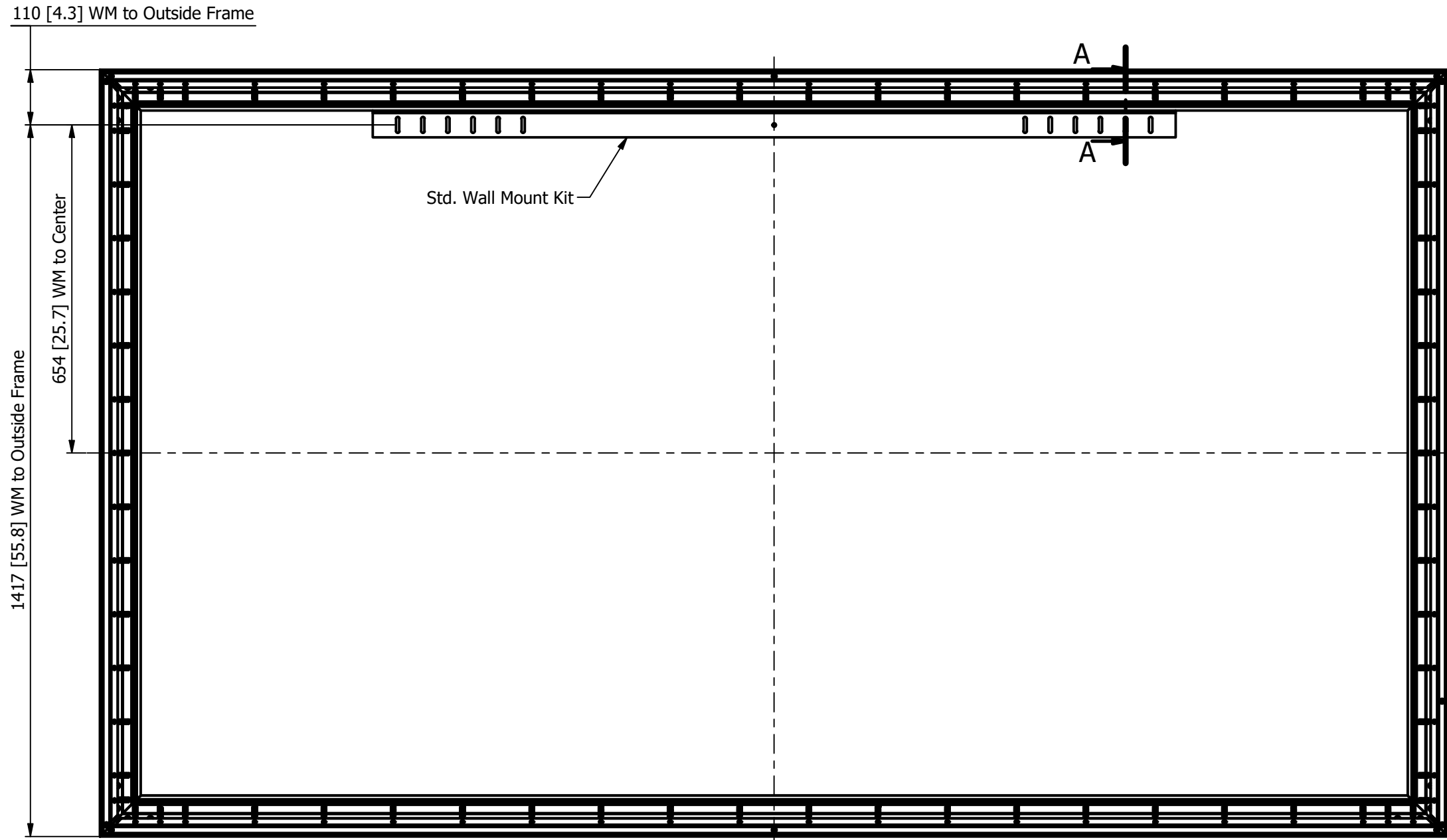

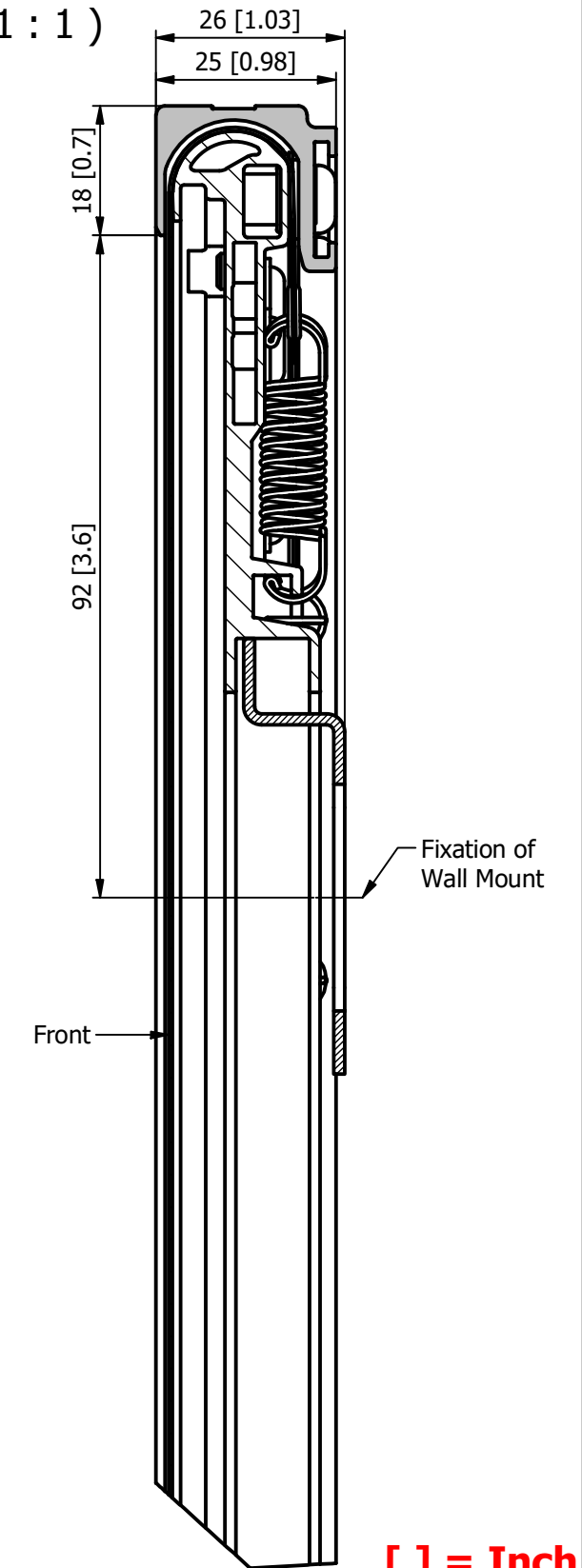

A-A (1:1)

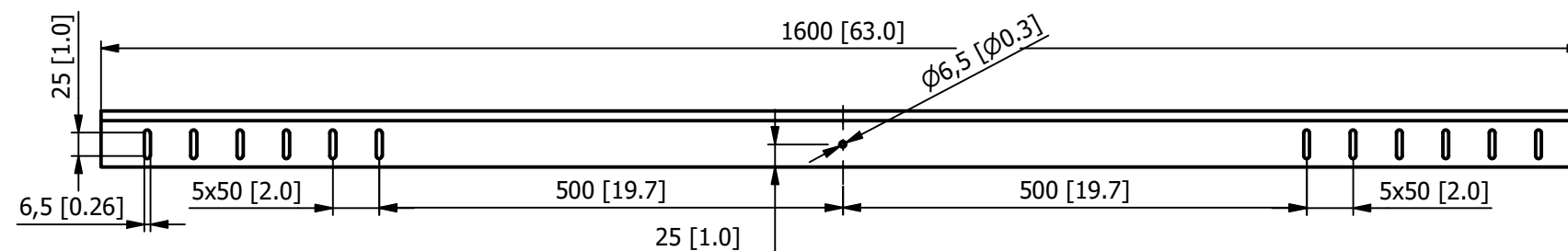

Standard Wall Mount (WM)

(1:7,5)



End user/project:				
Order No.:		Customer:		
dnp no.	Rev/Date/int:	Supplier:		
 dnp denmark as Skruengang 2 DK-2690 Karlslunde Denmark Tel.: +45 46 16 51 00 Website: www.dnp-screens.com	Scale:	Date:	Sign.:	
	1:10	25/02/2019	GA	
Description: Supernova STW 120" 16:9 Rear view		Sheet: 2 of 2	Format: A3	
		Drawing No: W - 538 24 120 100		

D:\# (GA) Tegninger (Sync)_221118\Div Produkter\STW NEW_Standard size\STW 120in 1.78W - 538 24 120 100.idw

Measure without tolerance according DS/ISO 2768-m

Copyright dnp denmark as