

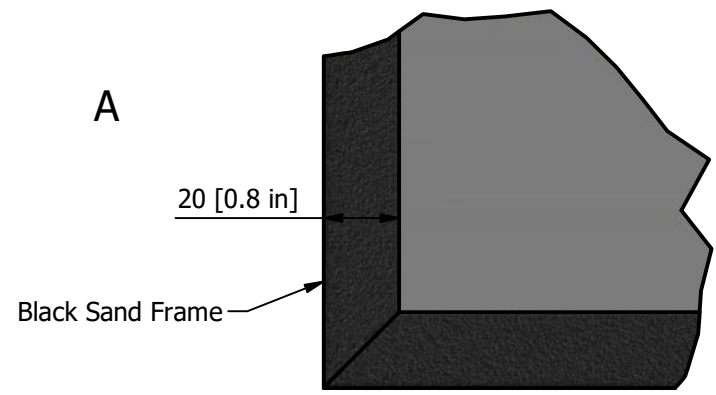

A

Weight: 22 kg - 48 lbs



Available with SN 08-85 or SN 23-23 screen material

End user/project:				
Order No.:		Customer:		
dnp no.	Rev/Date/int: 00 / 24.03.20 / GA	Supplier:		
 dnp denmark as Skruegangen 2 DK-2690 Karlslunde Denmark Tel.: +45 46 16 51 00 Website: www.dnp-screens.com	Scale:	Date:	Sign.:	
		24/03/2020	GA	
Description: SNO 100in 16:10 - Black Sand Layout		Sheet: 1 of 2	Format: A3	
		Drawing No: 511 MM 100 316_SNO		

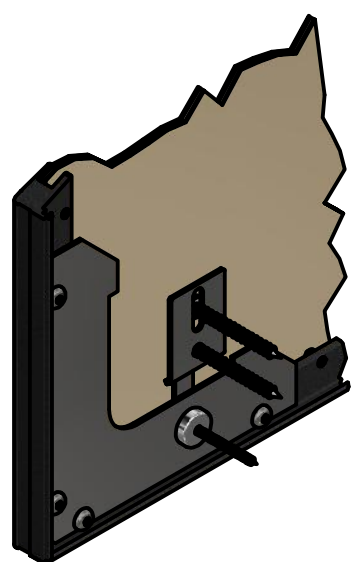
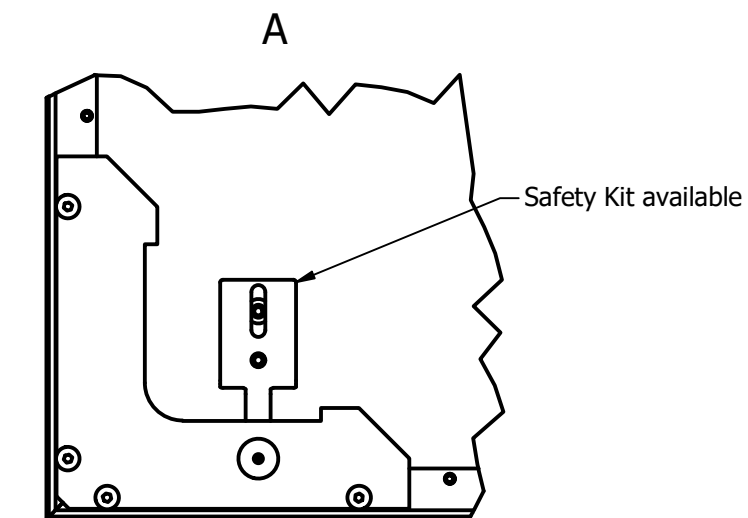
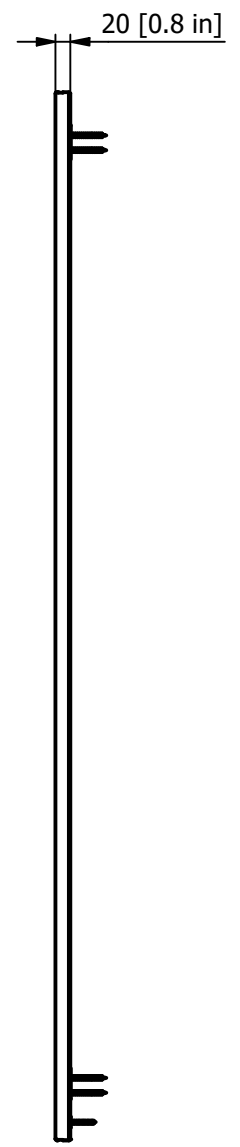
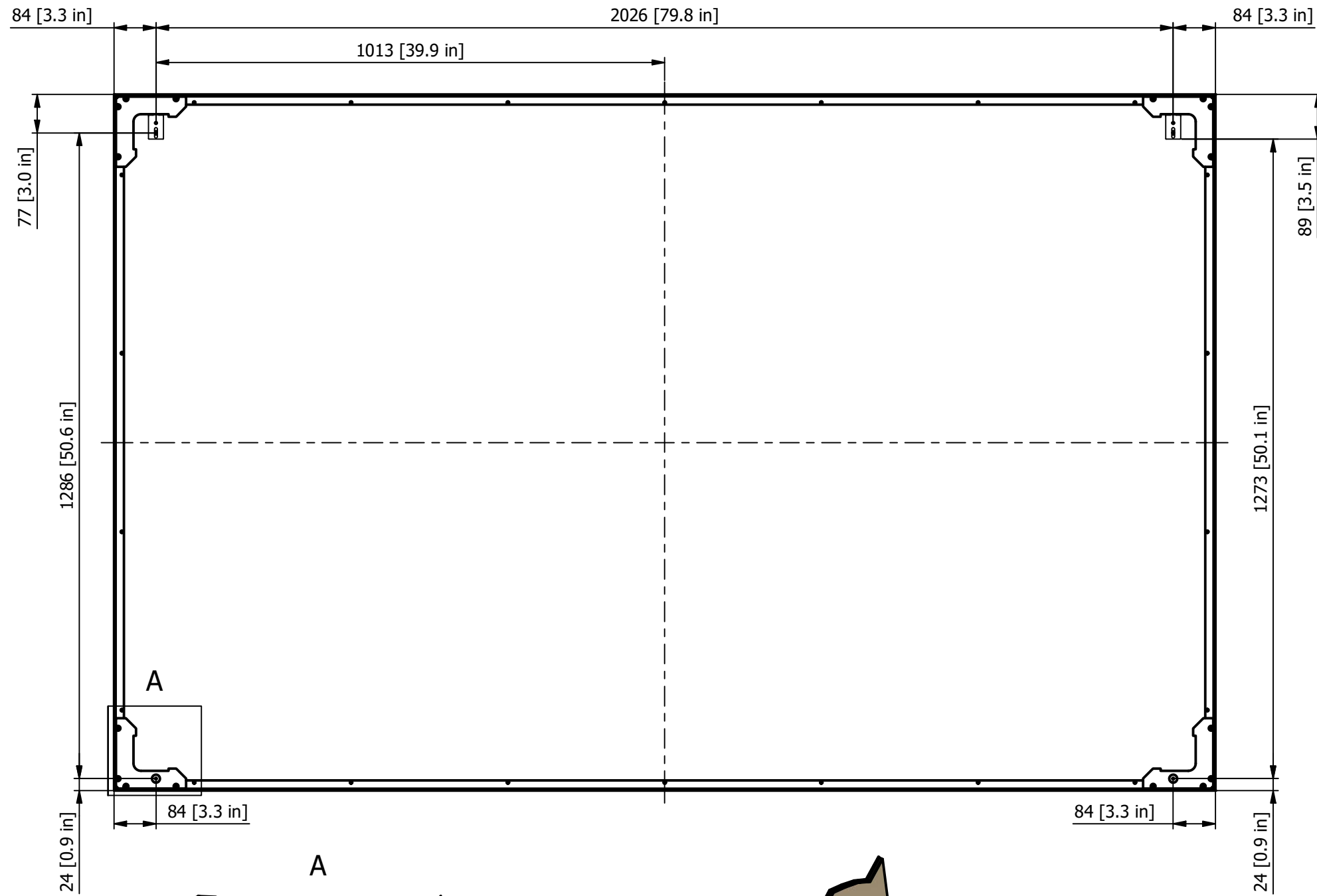

End user/project:				
Order No.:		Customer:		
dnp no.	Rev/Date/int: 00 / 24.03.20 / GA	Supplier:		
 dnp denmark as Skruegangen 2 DK-2690 Karlslunde Denmark Tel.: +45 46 16 51 00 Website: www.dnp-screens.com	Scale:	Date:	Sign.:	
		24/03/2020	GA	
Description: SNO 100in 16:10 - Black Sand Backside		Sheet: 2 of 2	Format: A3	
		Drawing No: 511 MM 100 316_SNO		
<small>D:\1# (GA) Tegninger [Sync]_221118\Div Produkter\SNO ONE_Med STS-SNO Frame\SNO 100in 1.60 bs\511 MM 100 316_SNO.idw</small>				

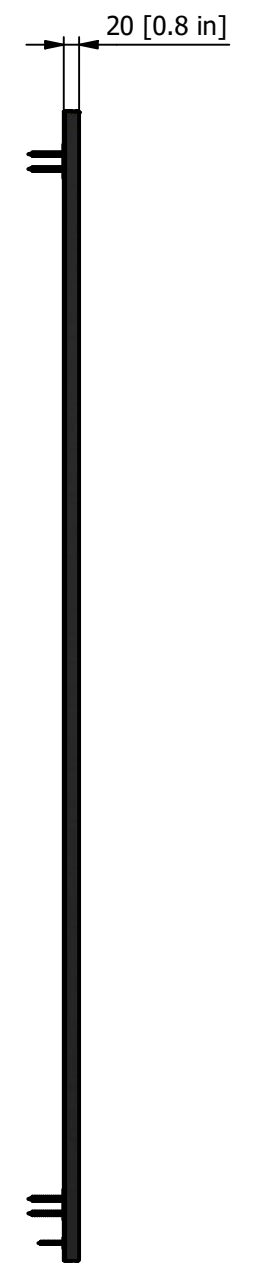
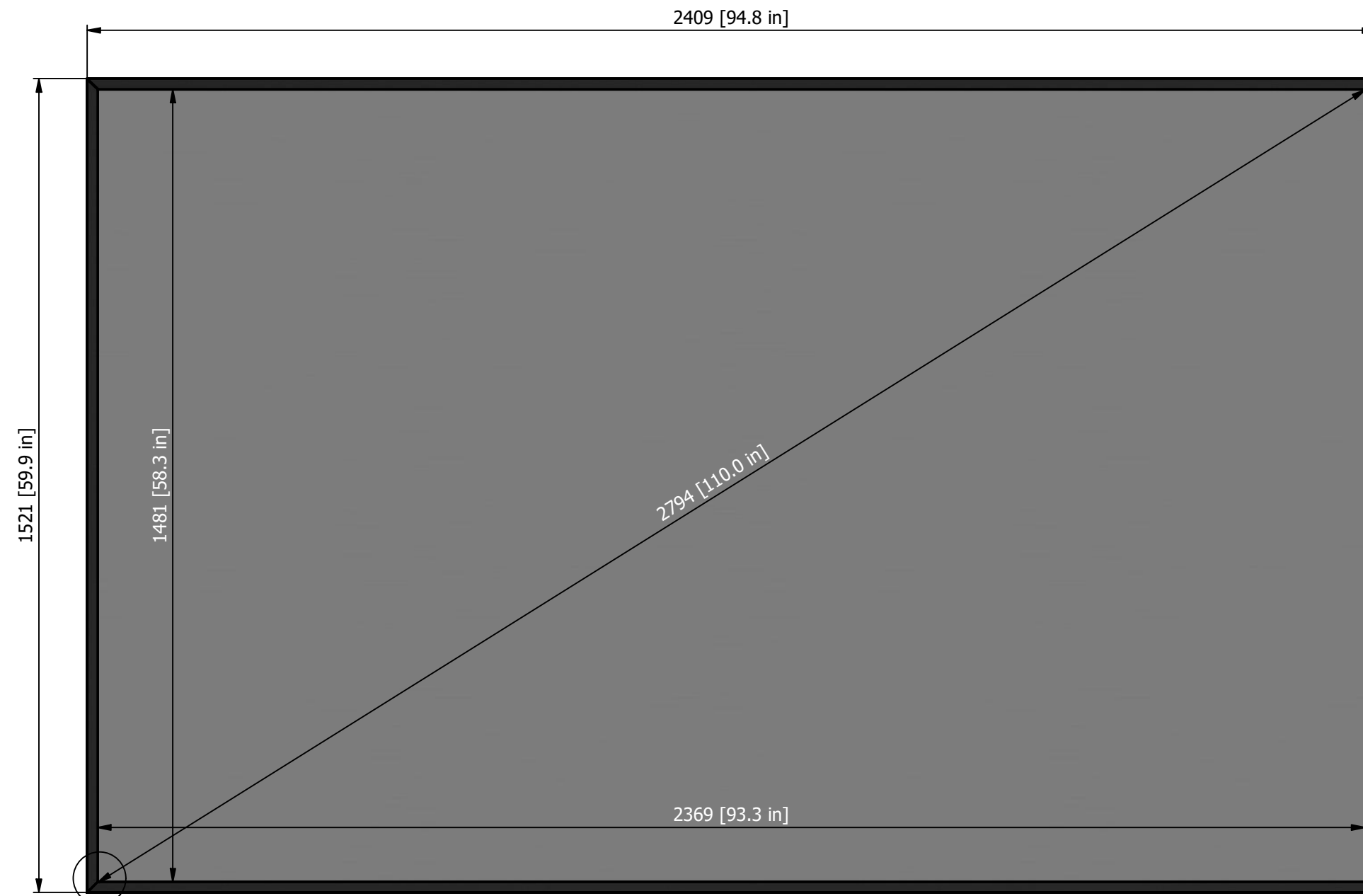

A

A (1 : 2)

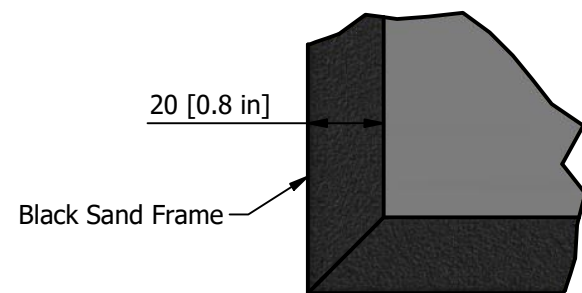

Black Sand Frame

Weight: 26 kg - 57 lbs

End user/project:				
Order No.:		Customer:		
dnp no.	Rev/Date/int: 00 / 24.03.20 / GA	Supplier:		
 dnp denmark as Skruegangen 2 DK-2690 Karlslunde Denmark Tel.: +45 46 16 51 00 Website: www.dnp-screens.com	Scale:	Date:	Sign.:	
		24/03/2020	GA	
Description: SNO 110in 16:10 - Black Sand Layout		Sheet: 1 of 2	Format: A3	
		Drawing No: 511 MM 110 316_SNO		

Available with SN 08-85 or SN 23-23 screen material

D:\P (GA) Tegninger (Sync)_221118\Div Produkter\SNO_One_Med STS-SNO Frame\SNO 110in 1.60 bs\511 MM 110 316_SNO.idw

Measure without tolerance according DS/ISO 2768-m

Copyright dnp denmark as

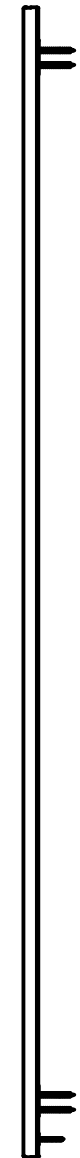
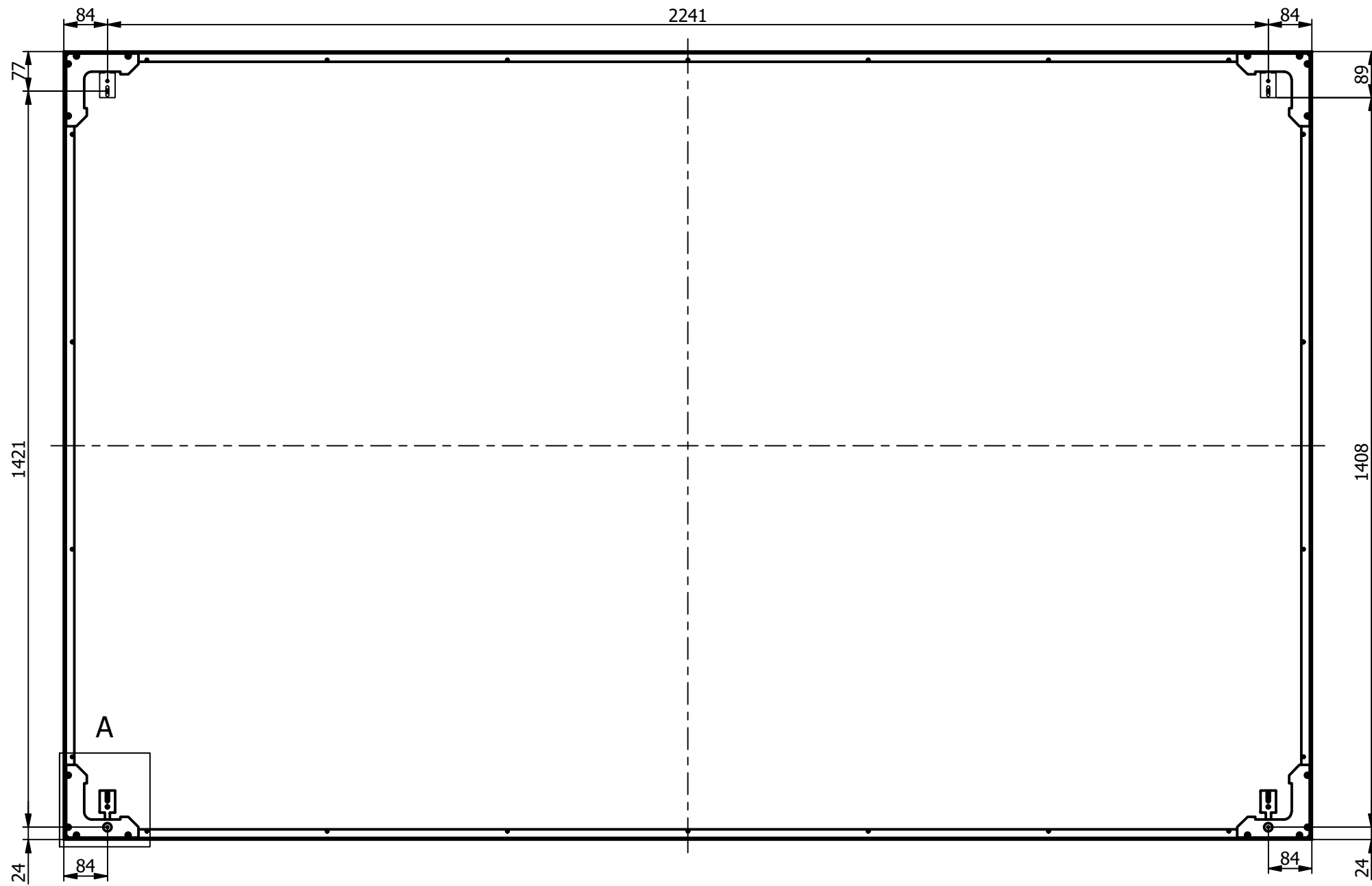

A

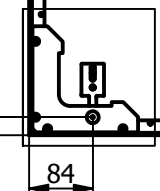

A

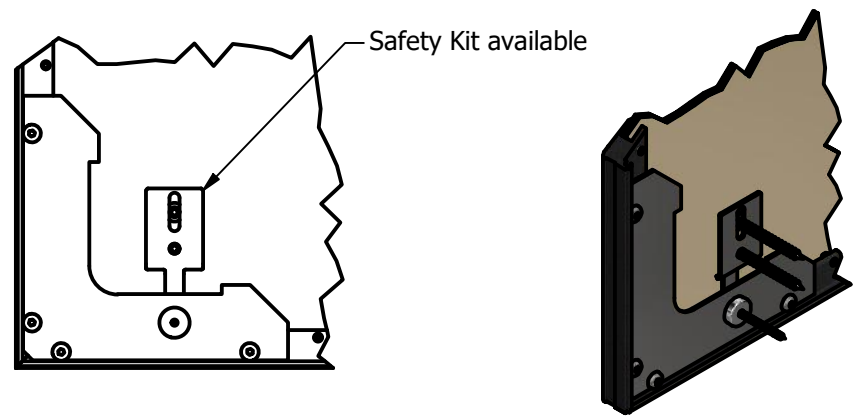

End user/project:				
Order No.:		Customer:		
dnp no.	Rev/Date/int: 00 / 24.03.20 / GA	Supplier:		
 dnp denmark as Skruengang 2 DK-2690 Karlslunde Denmark Tel.: +45 46 16 51 00 Website: www.dnp-screens.com	Scale:	Date:	Sign.:	
		24/03/2020	GA	
Description:		Sheet: 2 of 2	Format: A3	
SNO 110in 16:10 - Black Sand Backside		Drawing No: 511 MM 110 316_SNO		
<small>D:\1# (GA) Tegninger (Sync)_221118\Draw Produkter\SN ONE_Med STS-SNO Frame\SNO 110in 1.60 bs\511 MM 110 316_SNO.idw</small>				

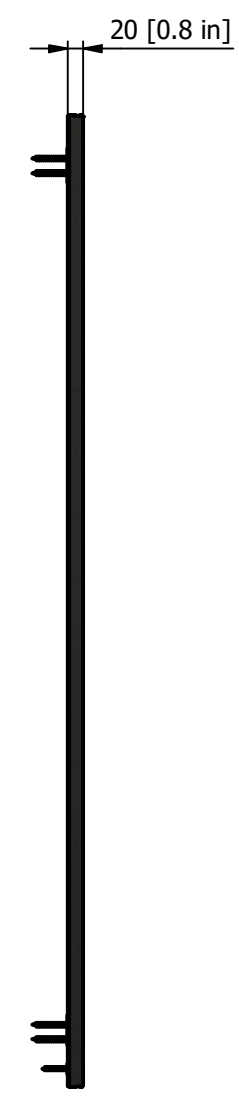
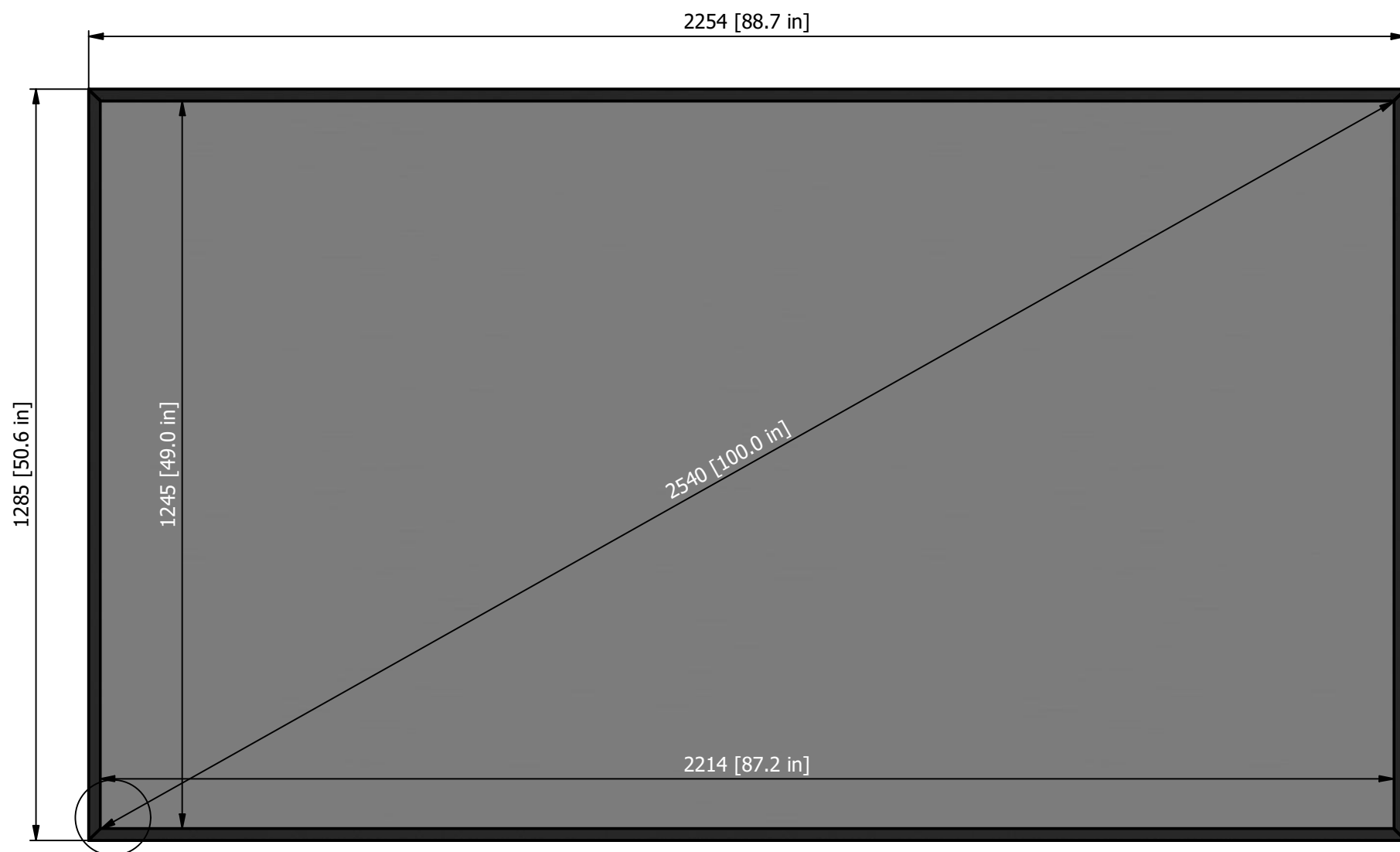

A

Weight: 21 kg - 46 lbs

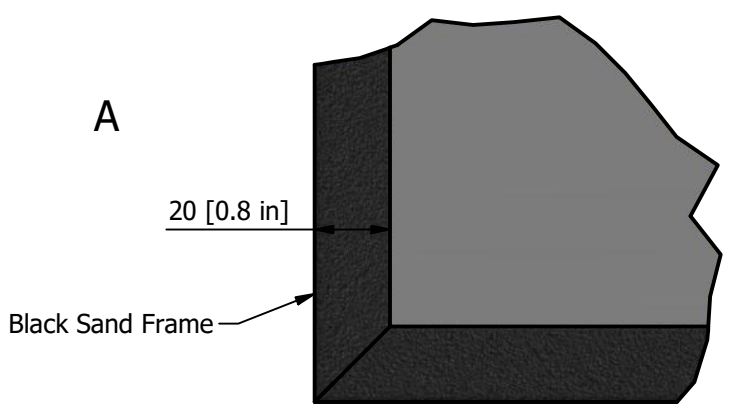

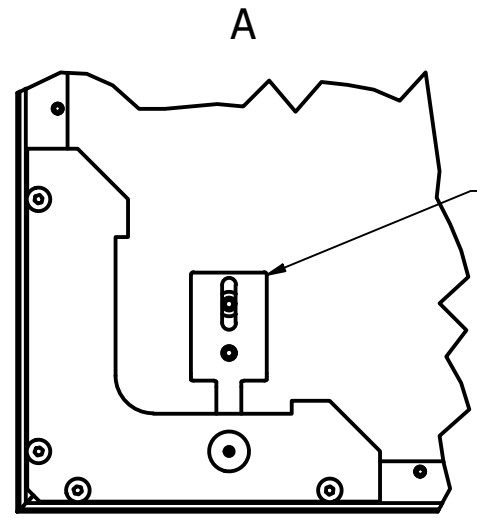
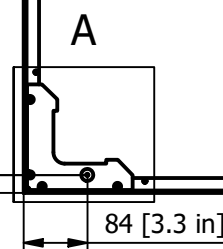
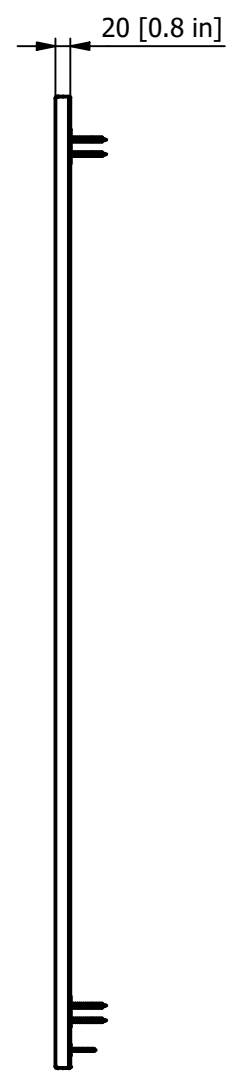
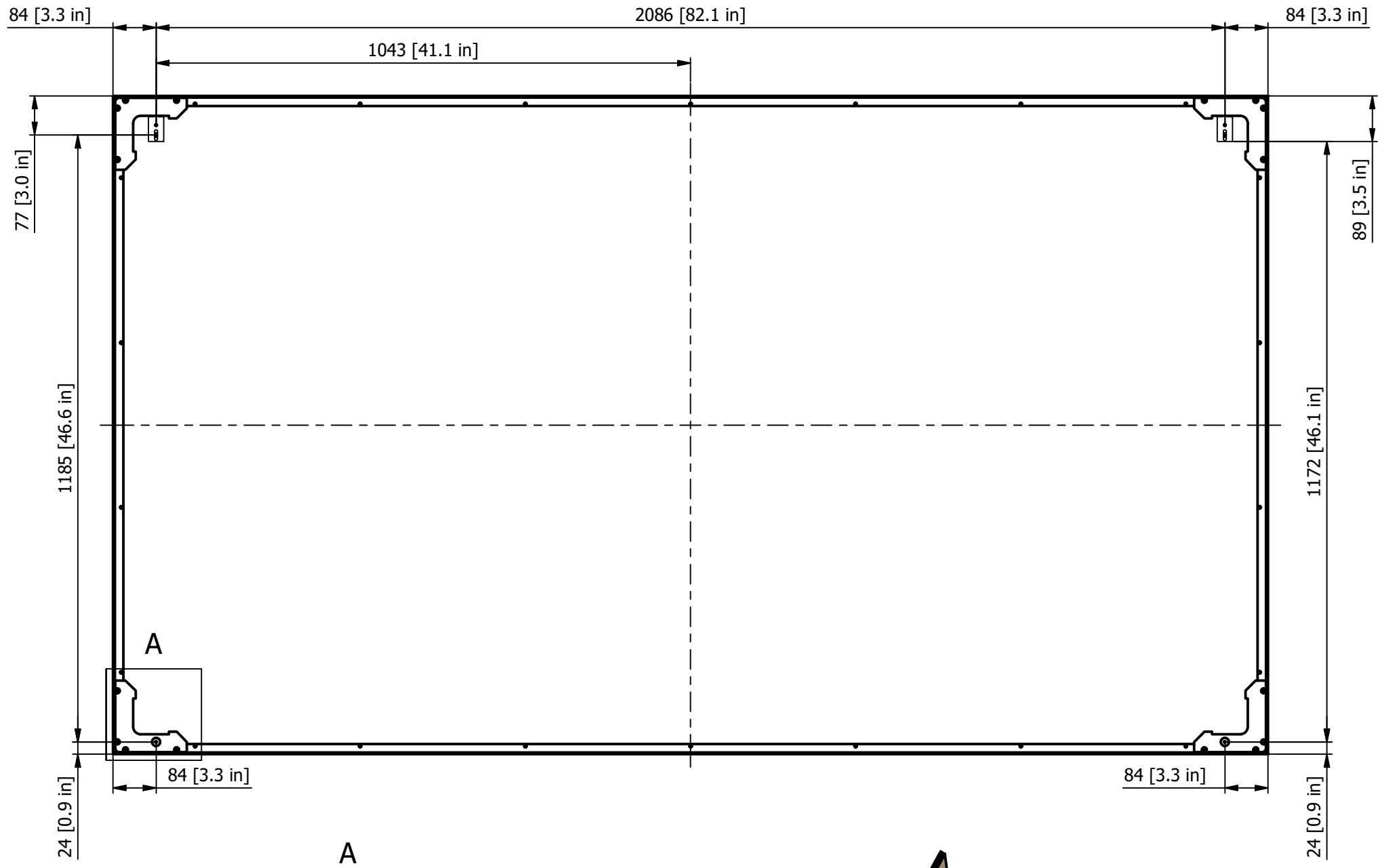

Available with SN 08-85 or SN 23-23 screen material

End user/project:				
Order No.:		Customer:		
dnp no.	Rev/Date/int: 00 / 24.03.20 / GA	Supplier:		
 dnp denmark as Skruengang 2 DK-2690 Karlslunde Denmark Tel.: +45 46 16 51 00 Website: www.dnp-screens.com	Scale:	Date:	Sign.:	
		24/03/2020	GA	
Description: SNO 100in 16:9 - Black Sand Layout		Sheet: 1 of 2	Format: A3	
		Drawing No: 511 MM 100 116_SNO		

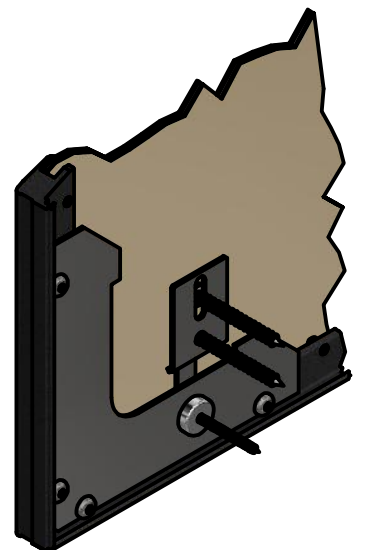

Safety Kit available



End user/project:				
Order No.:		Customer:		
dnp no.	Rev/Date/int: 00 / 24.03.20 / GA	Supplier:		
 dnp denmark as Skruengangen 2 DK-2690 Karlslunde Denmark Tel.: +45 46 16 51 00 Website: www.dnp-screens.com	Scale:	Date:	Sign.:	
		24/03/2020	GA	
Description: SNO 100in 16:9 - Black Sand Backside		Sheet: 2 of 2	Format: A3	
		Drawing No: 511 MM 100 116_SNO		

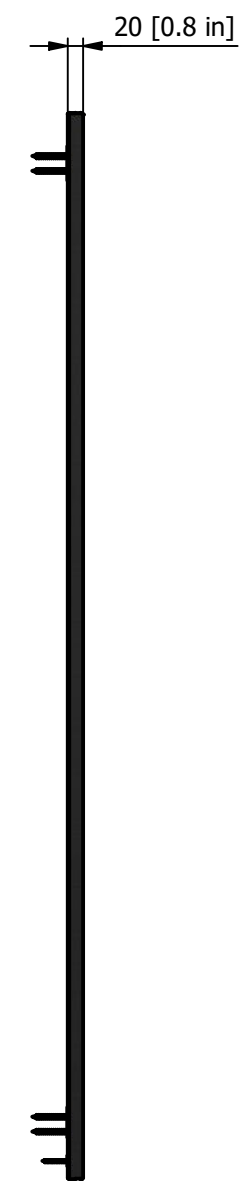
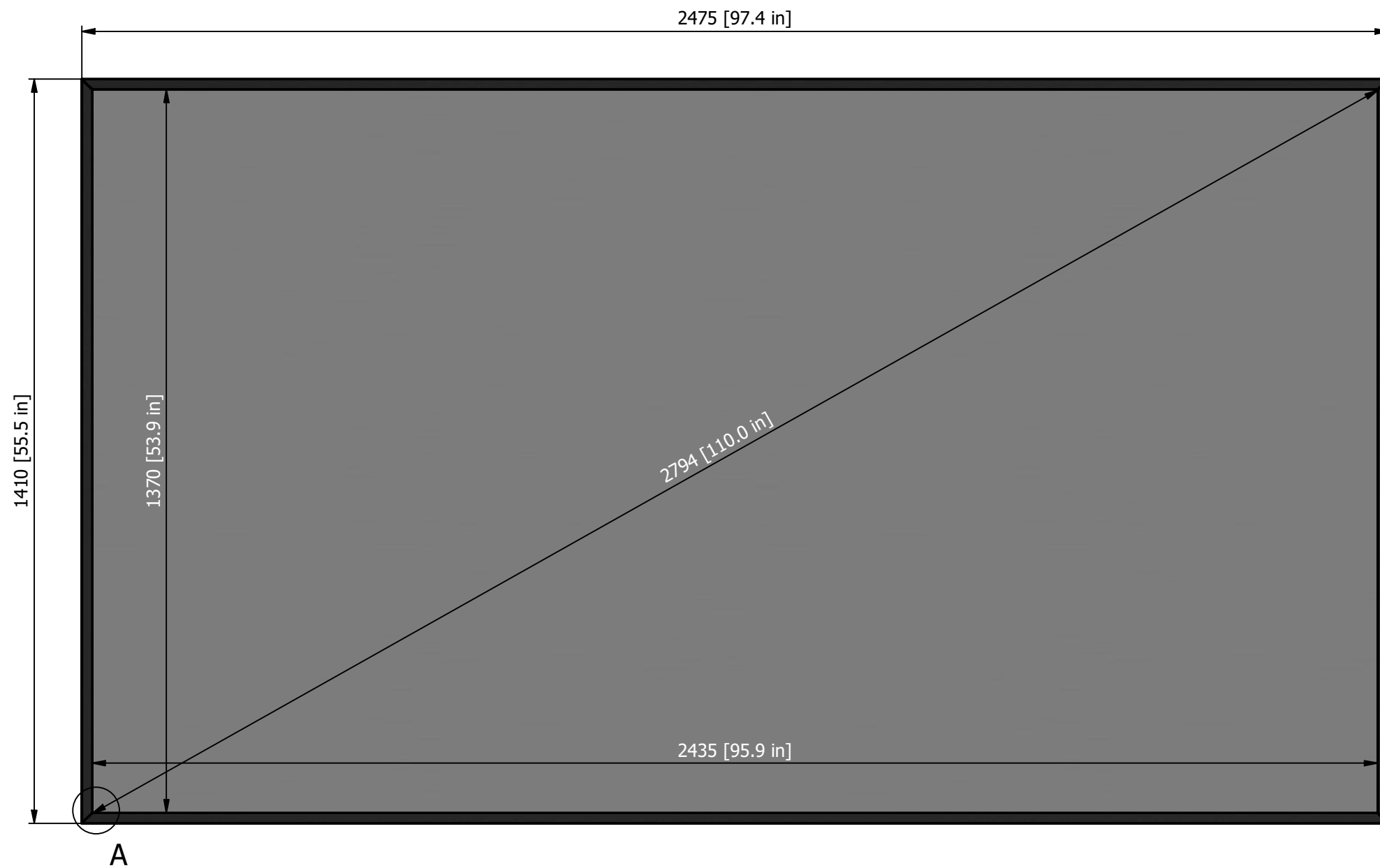

A (1 : 2)

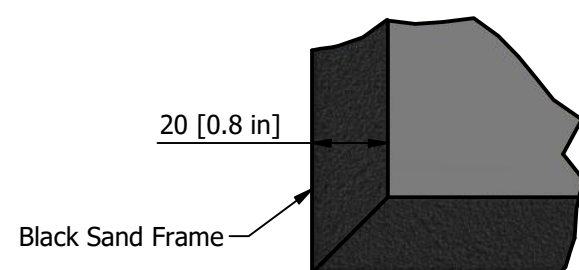

Weight: 25 kg - 55 lbs

Available with SN 08-85 or SN 23-23 screen material

End user/project:				
Order No.:		Customer:		
dnp no.	Rev/Date/int: 00 / 24.03.20 / GA	Supplier:		
 dnp denmark as Skruegangen 2 DK-2690 Karlslunde Denmark Tel.: +45 46 16 51 00 Website: www.dnp-screens.com	Scale:	Date:	Sign.:	
		24/03/2020	GA	
Description: SNO 110in 16:9 - Black Sand Layout		Sheet: 1 of 2	Format: A3	
		Drawing No: 511 MM 110 116_SNO		
<small>D:\1# (GA) Tegninger (Sync)_221118\Div Produkter\SN ONE_Med STS-SNO Frame\SNO 110in 1.78 bs\511 MM 110 116_SNO.idw</small>				

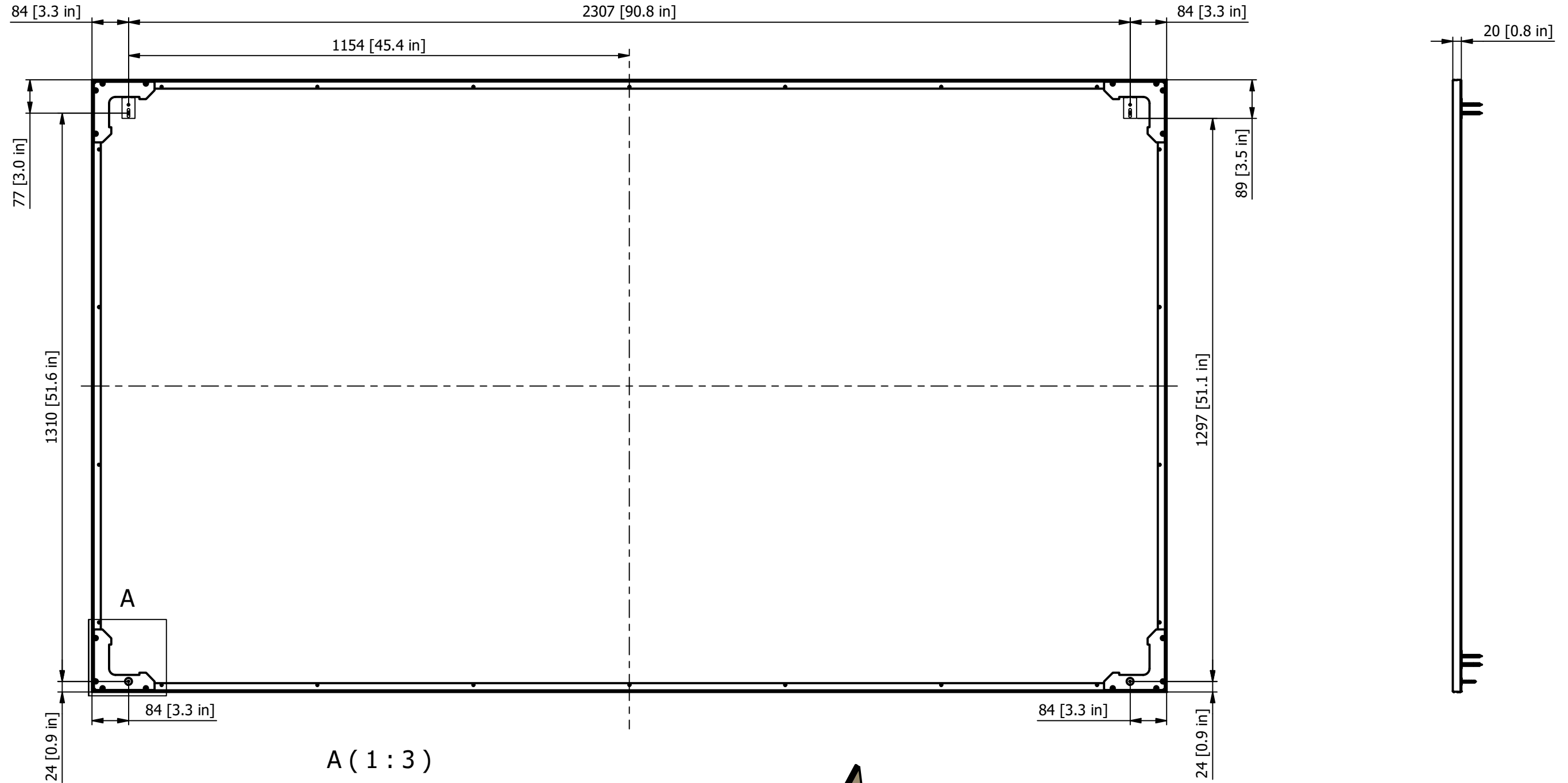

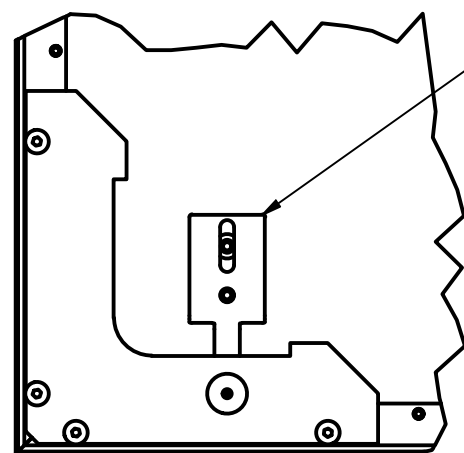

A

A (1:3)

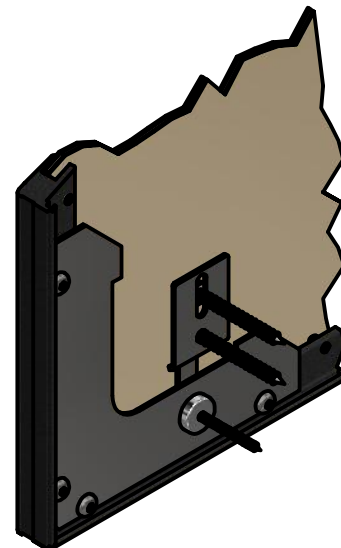

Safety Kit available



End user/project:				
Order No.:		Customer:		
dnp no.	Rev/Date/int: 00 / 24.03.20 / GA	Supplier:		
 dnp denmark as Skrugangen 2 DK-2690 Karlslunde Denmark Tel.: +45 46 16 51 00 Website: www.dnp-screens.com	Scale:	Date:	Sign.:	
		24/03/2020	GA	
Description: SNO 110in 16:9 - Black Sand Backside		Sheet: 2 of 2	Format: A3	
		Drawing No: 511 MM 110 116_SNO		

D:\# (GA) Tegninger (Sync)_221118\Div Produkter\SNO ONE_Med STS-SNO Frame\SNO 110in 1.78 bs\511 MM 110 116_SNO.idw

Measure without tolerance according to DS/ISO 2768-m

Copyright dnp denmark as

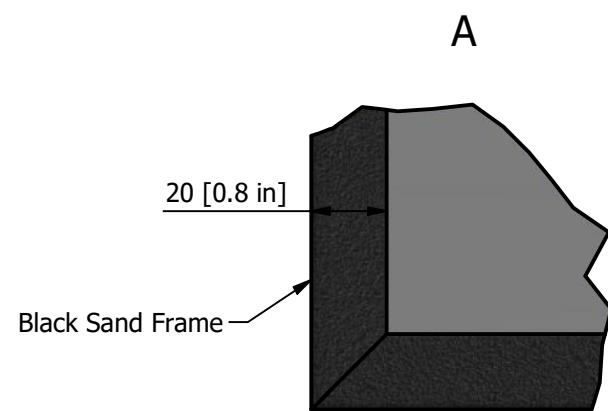
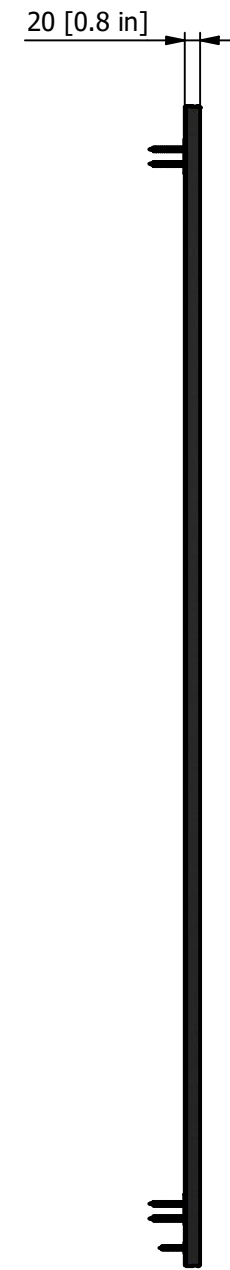
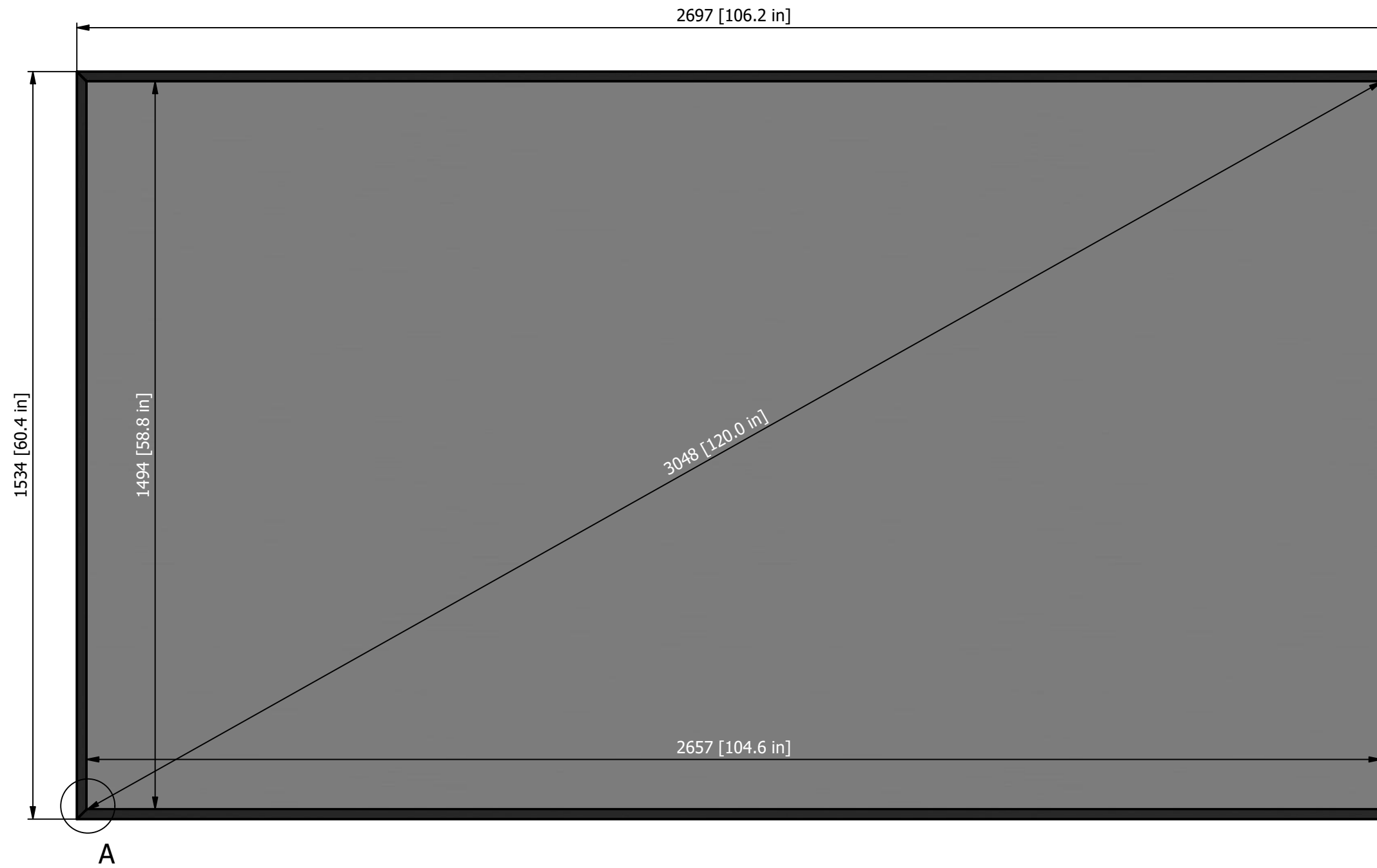

Weight: 29 kg - 64 lbs

End user/project:				
Order No.:		Customer:		
dnp no.	Rev/Date/int: 00 / 24.03.20 / GA	Supplier:		
 dnp denmark as Skruegangen 2 DK-2690 Karlslunde Denmark Tel.: +45 46 16 51 00 Website: www.dnp-screens.com	Scale:	Date:	Sign.:	
		24/03/2020	GA	
Description: SNO 120in 16:9 - Black Sand Layout		Sheet: 1 of 2	Format: A3	
		Drawing No: 511 MM 120 116_SNO		
<small>D:\1# (GA) Tegninger [Sync]_221118\Div Produkter\SNO_One_Med STS-SNO Frame\SNO 120in 1.78 bs\511 MM 120 116_SNO.idw</small>				

Available with SN 08-85 or SN 23-23 screen material

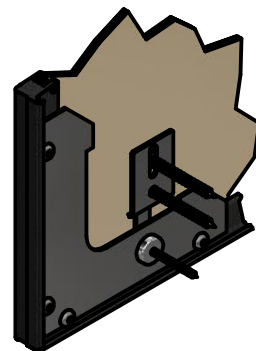
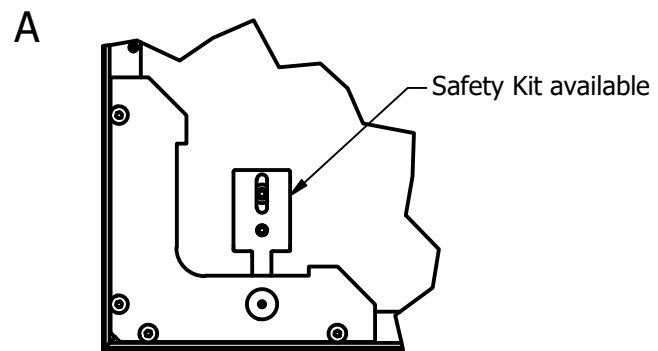
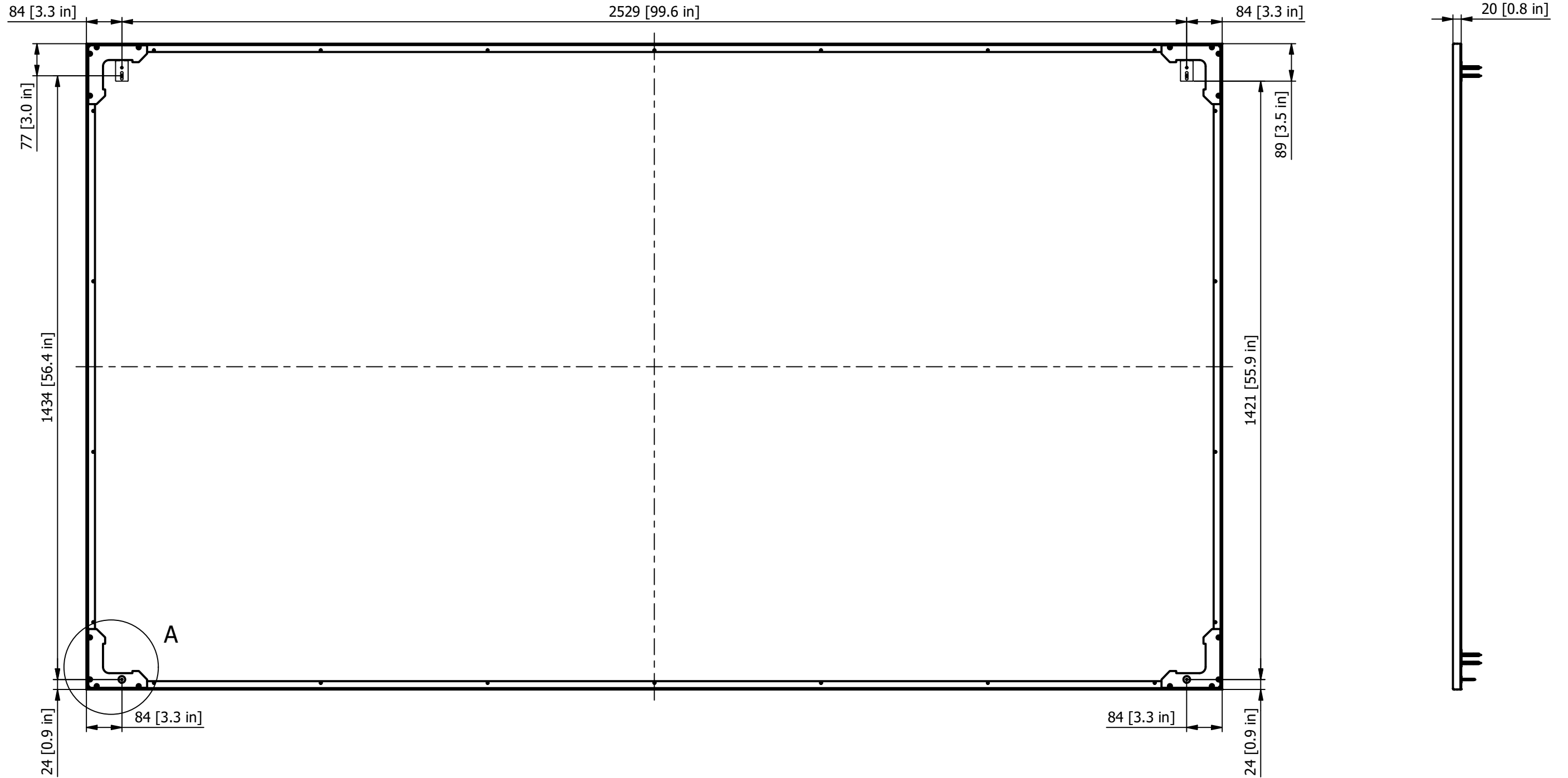

End user/project:				
Order No.:		Customer:		
dnp no.	Rev/Date/int: 00 / 24.03.20 / GA	Supplier:		
 dnp denmark as Skruengang 2 DK-2690 Karlslunde Denmark Tel.: +45 46 16 51 00 Website: www.dnp-screens.com	Scale:	Date:	Sign.:	
		24/03/2020	GA	
Description: SNO 120in 16:9 - Black Sand Backside		Sheet: 2 of 2	Format: A3	
		Drawing No: 511 MM 120 116_SNO		
<small>D:\# (GA) Tegninger [Sync]_221118\Div Produkter\SNO ONE_Med STS-SNO Frame\SNO 120in 1.78 bs\511 MM 120 116_SNO.dwg</small>				